

○ Avec ou sans mécanique  
 With or without mechanical elements  
 Con o senza parti meccaniche  
 Mit oder ohne Aggregate  
 Con ó sin mecanica desmontada

REP.	REFERENCE	PDS	NB	MZ
1	894.7001	3,5	1	141
2	894.7002	3,5	1	142
3	894.7003	2,1	1	260/140
4	894.7004	2,1	1	260/140
5	894.7005	1,1	2	
6	894.7006	3,0	1	260
7	894.7007	3,0	1	260
8	894.7008	3,6	1	602
9	894.7009	3,6	1	601
10	894.7010	1,7	1	140
11	894.7011	1,7	1	140
12	894.7012	2,3	1	080
13	894.7013	2,3	1	080
14	894.7014	2,3	1	200/142
15	894.7015	2,3	1	200/141
16	894.7016	2,8	1	200
17	894.7017	2,8	1	200
18	894.7018	3,0	1	260
19	894.7019	3,0	1	260
20	894.7020	2,4	1	080
21	894.7021	2,4	1	080
	D.080	0,5	2	

	M 12-30	2
	M 14-90	2
	M 14x1,50-60	2
	M 14x1,50-80	2
	M 14x1,50-130	6
	M 14x1,50-140	4
	M 14x1,50-150	2
M 14x1,50-180	2	

	M 10	4
--	------	---

**LAND ROVER**

**894.300**

58 Kg 19.09.2002 404-D-20A

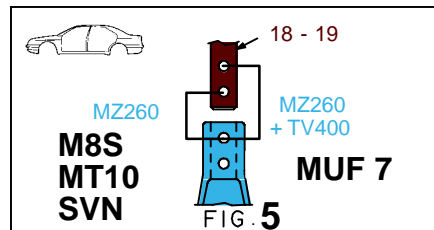
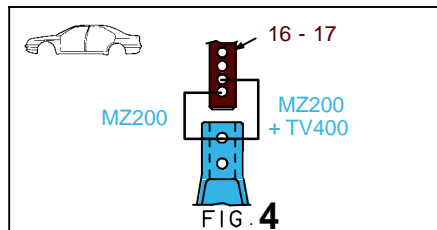
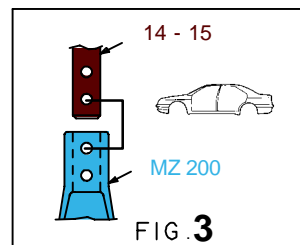
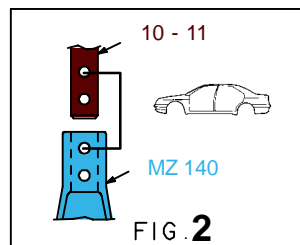
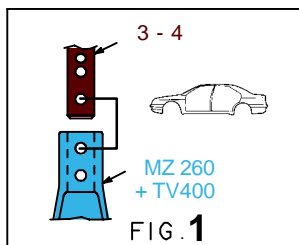
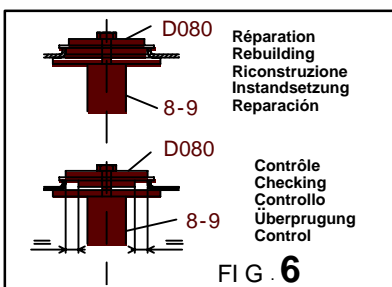
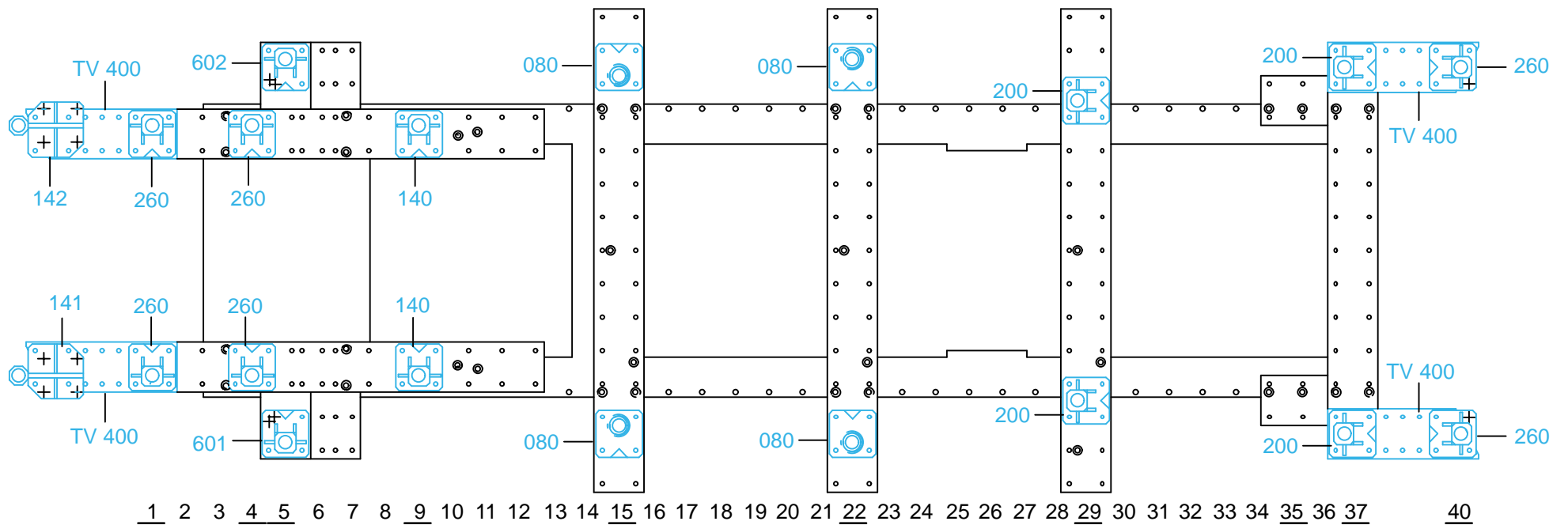

894.300-RVA3-1 00

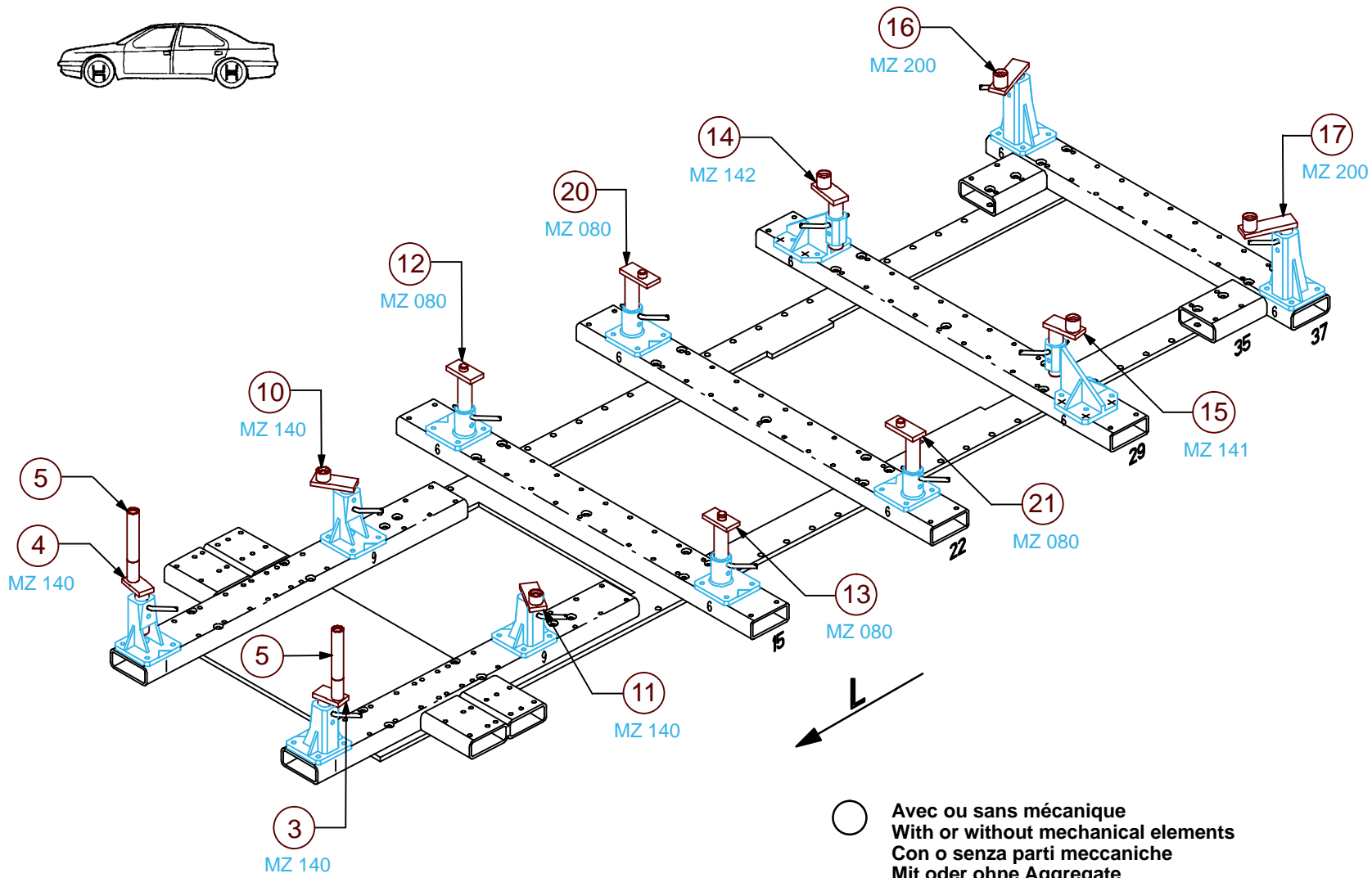

○ Avec ou sans mécanique  
 With or without mechanical elements  
 Con o senza parti meccaniche  
 Mit oder ohne Aggregate  
 Con ó sin mecanica desmontada

**LAND ROVER**

**894.300**

58 Kg    22.03.2005    404-D-20B

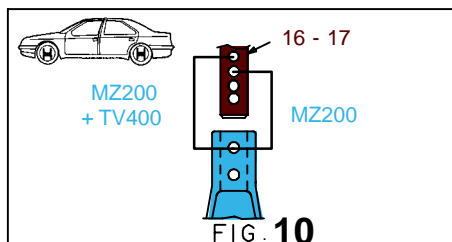
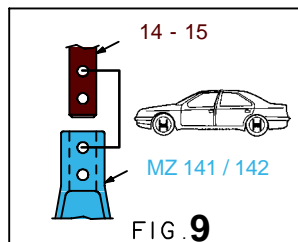
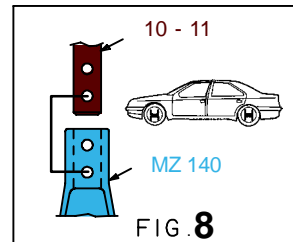
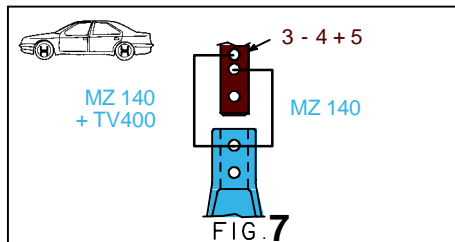
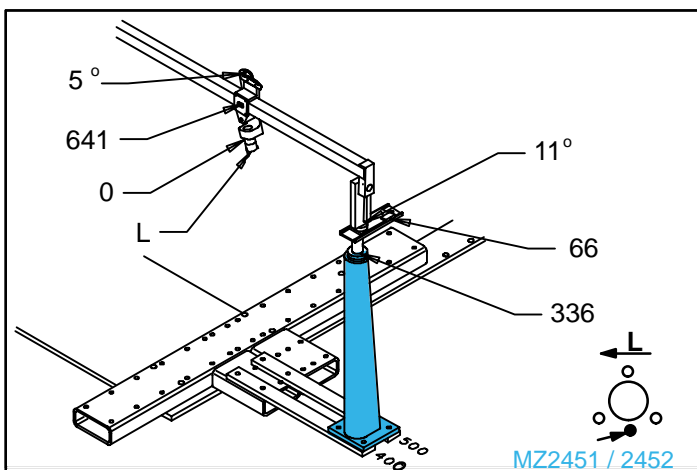
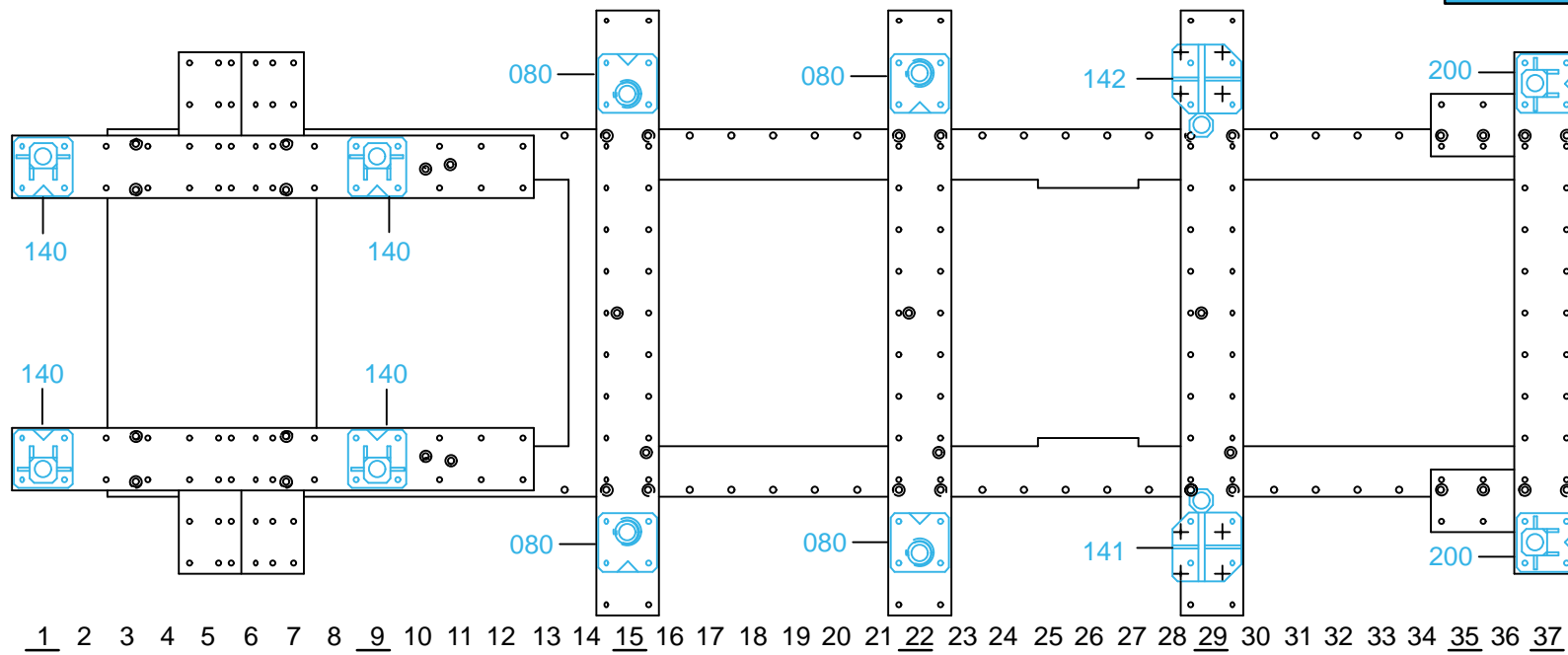

894.300-RVA3-1 00